



### Main features

- Robust stainless housing for harsh environment conditions
- Abrasive and chemical resistant due to ceramic measurement cell
- External programming of zero point and span with FlexProgrammer 9701

### Applications

- Pneumatic
- Medical gas
- Factory automation
- HVAC
- Agriculture vehicles
- Energy

### Technical specifications

Measuring principle	Thick film on ceramic
Measuring ranges	-1 ... 0 bar up to 0 ... 600 bar
Type of pressure	Relative / Absolute
Accuracy (20 °C) <small>(includes linearity, hysteresis, repeatability, error of span and zero point according limit point adjustment)</small>	≤ 0.7% FS ≤ 0.5% FS
Turn down	2:1
Performance after Turn down	[Turn-Down] * [Accuracy] FS
Zero thermal drift	≤ ± 0.08% FS/10 K
Span thermal drift	≤ ± 0.08% FS/10 K
Long term stability	0.2% FS / Year
Response time (10 ... 90%)	≤ 5 ms
Process connections	See page 3

### Environment

Temperature	
Storage	-40 ... + 100°C
Compensated range	-20 ... + 60°C
Medium	
NBR	-30 ... + 100°C
EPDM	-40 ... + 125°C
FKM (Viton®)	-20 ... + 125°C
Ambient	-20 ... + 85°C
Protection rating	IP65 (EN 60529) up to IP67 depending on electrical connection
Vibration IEC60068-2-6	1.5 mm p-p (10 – 55 Hz), 10 g (55 Hz – 2 KHz) 3 cycles within 2.5 h per axis

Shock IEC60068-2-27	50 g/11 ms 100 g/6 ms 3 x Imp. per Axis and direction
Bump IEC60068-2-27	100 g/2 ms 4000 x Imp. per axis and direction
Random IEC60068-2-64	0.1 g <sup>2</sup> /Hz (20 Hz – 1 KHz) 30 min per axis (>10 g RMS)

### Electrical specification

Output signal / Power supply	4 ... 20 mA / 8 ... 32 VDC 0...10 V / 13 ... 32 VDC
Load impedance	
Current output	$R_o = (U_{supply} - 8 V) / 20 mA$
Voltage output	> 5 KΩ
Insulation resistance	>100 MΩ at 500 VDC
Electrical connections	See page 3

### Material

Process connection	SS 1.4404 AISI 316L
Housing	SS 1.4301 AISI 304
Diaphragm	Ceramic (96% Al <sub>2</sub> O <sub>3</sub> )
Sealing	NBR, EPDM, FKM (Viton®)
Cable	PUR

### Approvals

CE conformity	EMC directive 2004/108/CE in accordance with EN 61000-6-2, EN 61000-6-3, EN 61326-1 (Tab.2) Pressure directive 97/23/CE
---------------	--

## Measuring ranges and overpressure safety

	Pressure in bar						
<b>Pressure range</b>	-1 ... 0 -1 ... 0.6 0 ... 1 0 ... 1.6	-1 ... 1.5 0 ... 2.5	-1 ... 3 0 ... 4	-1 ... 5 0 ... 6	-1 ... 9 0 ... 10	-1 ... 15 0 ... 16	-1 ... 24 0 ... 25
<b>Over pressure</b>	2	4	8	12	20	32	50
<b>Burst pressure</b>	3	7	12	18	30	48	75

	Pressure in bar						
<b>Pressure range</b>	-1 ... 39 0 ... 40	0 ... 60	0 ... 100	0 ... 160	0 ... 250	0 ... 400	0 ... 600
<b>Over pressure</b>	80	120	200	320	360	600	800
<b>Burst pressure</b>	120	180	300	480	480	800	1000

## Electrical connections

Signal at 4...20 mA / Signal at 0...10V

### M12 4-pins

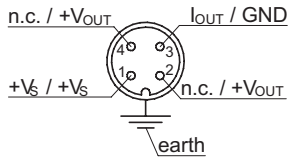

### Connector DIN 43650

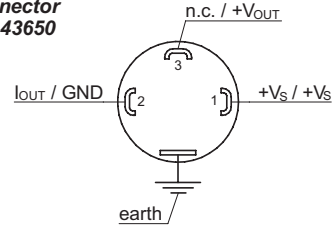

### Cable output

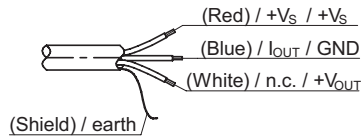

## Dimensions (mm)

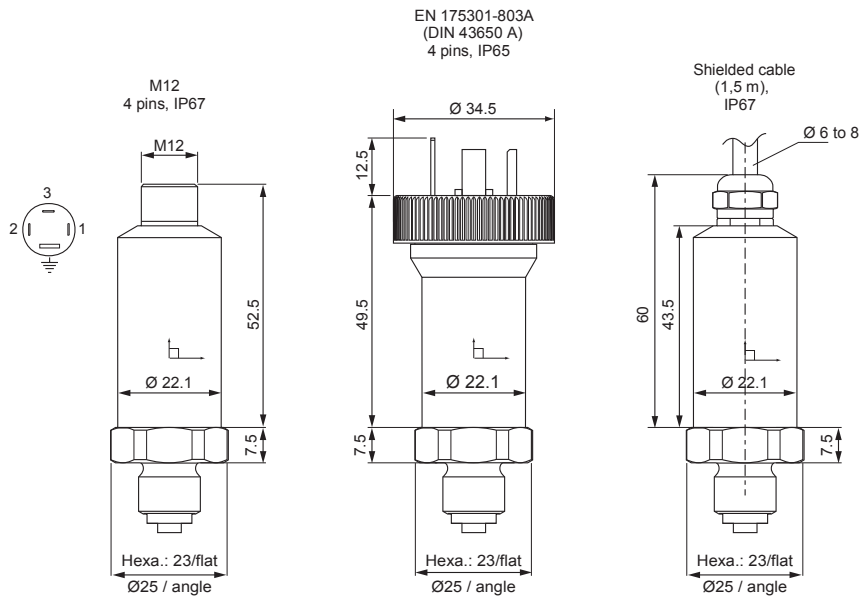

## Hydraulic connections

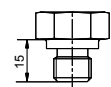

G 1/4 DIN 3852-E

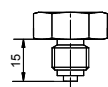

G 1/4 EN837

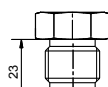

G 1/2 EN837

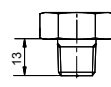

1/4 NPT

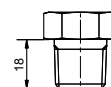

1/2 NPT

## Ordering details PBSN

	PBSN	-	1	.	x	.	xxx	.	x	.	xx	.	xx	.	xx	.	x	.	x
<b>Model</b>	Pressure transmitter	PBSN	-																
<b>Housing material</b>	Stainless steel 1.4301 AISI 304		1	.															
<b>Accuracy</b>	0.7% FS																		2
	0.5% FS																		3
<b>Pressure range and unit in bar</b>																			
	-1...0																		B59
	-1...0.6																		B72
	-1...1.5																		B74
	-1...3																		B76
	-1...5																		B77
	-1...9																		B79
	-1...15																		B81
	-1...24																		B82
	-1...39																		B1L
	0...1																		B15
	0...1.6																		B16
	0...2.5																		B18
	0...4																		B19
	0...6																		B20
	0...10																		B22
	0...16																		B24
	0...25																		B26
	0...40																		B27
	0...60																		B29
	0...100																		B31
	0...160																		B33
	0...250																		B35
	0...400																		B38
	0...600																		B39
<b>Kind of pressure</b>	Absolute																		A
	Relative																		R
<b>Output signal</b>	4...20mA																		A1
	0...10V																		A2
<b>Output connection</b>	M12, 4 pins																		14
	DIN 43650, 4 pins																		44
	Shielded cable (1.5 m)																		53
<b>Process connection</b>	G $\frac{1}{4}$ EN 837																		02
	G $\frac{1}{2}$ EN 837																		03
	$\frac{1}{4}$ NPT																		04
	$\frac{1}{2}$ NPT																		05
	G $\frac{1}{4}$ DIN 3852																		06
<b>Process connection material</b>	Stainless steel 1.4404 AISI 316L																		2
<b>Sealing</b>	NBR																		1
	EPDM																		2
	FKM (Viton®)																		3